

# 2SA1381/KSA1381

## PNP Epitaxial Silicon Transistor

### Applications

- Audio, Voltage Amplifier and Current Source
- CRT Display, Video Output
- General Purpose Amplifier

### Features

- High Voltage :  $V_{CEO} = -300V$
- Low Reverse Transfer Capacitance :  $C_{re} = 2.3pF$  at  $V_{CB} = -30V$
- Excellent Gain Linearity for low THD
- High Frequency: 150MHz
- Full thermal and electrical Spice models are available
- Complement to 2SC3503/KSC3503

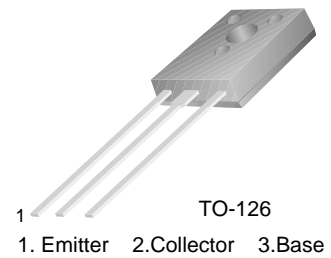

### Absolute Maximum Ratings\* $T_a = 25^\circ C$ unless otherwise noted

| Symbol         | Parameter   | Ratings     | Units      |
|----------------|---|-------------|------------|
| $BV_{CBO}$     | Collector-Base Voltage  | -300        | V          |
| $BV_{CEO}$     | Collector-Emitter Voltage                                       | -300        | V          |
| $BV_{EBO}$     | Emitter-Base Voltage  | -5          | V          |
| $I_C$          | Collector Current(DC)   | -100        | mA         |
| $I_{CP}$       | Collector Current(Pulse)  | -200        | mA         |
| $P_C$          | Total Device Dissipation, $T_C=25^\circ C$<br>$T_C=125^\circ C$ | 7<br>1.2    | W<br>W     |
| $T_J, T_{STG}$ | Junction and Storage Temperature                                | - 55 ~ +150 | $^\circ C$ |

\* These ratings are limiting values above which the serviceability of any semiconductor device may be impaired.

### Thermal Characteristics\* $T_a=25^\circ C$ unless otherwise noted

| Symbol          | Parameter                            | Max. | Units        |
|-----------------|--------------------------------------|------|--------------|
| $R_{\theta JC}$ | Thermal Resistance, Junction to Case | 17.8 | $^\circ C/W$ |

\* Device mounted on minimum pad size

### $h_{FE}$ Classification

| Classification | C       | D        | E         | F         |
|----------------|---------|----------|-----------|-----------|
| $h_{FE}$       | 40 ~ 80 | 60 ~ 120 | 100 ~ 200 | 160 ~ 320 |

**Electrical Characteristics\***  $T_a=25^\circ\text{C}$  unless otherwise noted

| Symbol        | Parameter                            | Test Condition                             | Min.  | Typ. | Max.  | Units         |
|---------------|--------------------------------------|--|-------|------|-------|---------------|
| $BV_{CBO}$    | Collector-Base Breakdown Voltage     | $I_C = -10\mu\text{A}, I_E = 0$            | - 300 |      |       | V             |
| $BV_{CEO}$    | Collector- Emitter Breakdown Voltage | $I_C = -1\text{mA}, I_B = 0$               | - 300 |      |       | V             |
| $BV_{EBO}$    | Emitter-Base Breakdown Voltage       | $I_E = -10\mu\text{A}, I_C = 0$            | - 5   |      |       | V             |
| $I_{CBO}$     | Collector Cut-off Current            | $V_{CB} = -200\text{V}, I_E = 0$           |       |      | - 0.1 | $\mu\text{A}$ |
| $I_{EBO}$     | Emitter Cut-off Current              | $V_{EB} = -4\text{V}, I_C = 0$             |       |      | - 0.1 | $\mu\text{A}$ |
| $h_{FE}$      | DC Current Gain                      | $V_{CE} = -10\text{V}, I_C = -10\text{mA}$ | 40    |      | 320   |               |
| $V_{CE(sat)}$ | Collector-Emitter Saturation Voltage | $I_C = -20\text{mA}, I_B = -2\text{mA}$    |       |      | - 0.6 | V             |
| $V_{BE(sat)}$ | Base-Emitter Saturation Voltage      | $I_C = -20\text{mA}, I_B = -2\text{mA}$    |       |      | - 1   | V             |
| $f_T$         | Current Gain Bandwidth Product       | $V_{CE} = -30\text{V}, I_C = -10\text{mA}$ |       | 150  |       | MHz           |
| $C_{ob}$      | Output Capacitance                   | $V_{CB} = -30\text{V}, f = 1\text{MHz}$    |       | 3.1  |       | pF            |
| $C_{re}$      | Reverse Transfer Capacitance         | $V_{CB} = -30\text{V}, f = 1\text{MHz}$    |       | 2.3  |       | pF            |

\* Pulse Test: Pulse Width $\leq$ 300 $\mu\text{s}$ , Duty Cycles $\leq$ 2%**Ordering Information**

| Part Number* | Marking  | Package | Packing Method | Remarks      |
|--------------|----------|---------|----------------|--------------|
| 2SA1381CSTU  | 2SA1381C | TO-126  | TUBE           | hFE1 C grade |
| 2SA1381DSTU  | 2SA1381D | TO-126  | TUBE           | hFE1 D grade |
| 2SA1381ESTU  | 2SA1381E | TO-126  | TUBE           | hFE1 E grade |
| 2SA1381FSTU  | 2SA1381F | TO-126  | TUBE           | hFE1 F grade |
| KSA1381CSTU  | A1381C   | TO-126  | TUBE           | hFE1 C grade |
| KSA1381DSTU  | A1381D   | TO-126  | TUBE           | hFE1 D grade |
| KSA1381ESTU  | A1381E   | TO-126  | TUBE           | hFE1 E grade |
| KSA1381FSTU  | A1381F   | TO-126  | TUBE           | hFE1 F grade |

- \* 1. Affix "-S-" means the standard TO126 Package.(see package dimensions). If the affix is "-STS-" instead of "-S-", that mean the short-lead TO126 package.  
 2. Suffix "-TU" means the tube packing. The Suffix "TU" could be replaced to other suffix character as packing method.

# Typical Characteristics

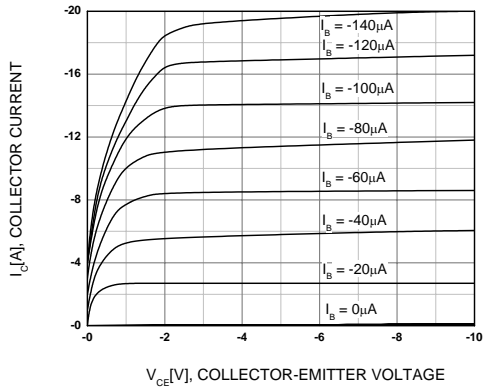

Figure 1. Static Characteristic

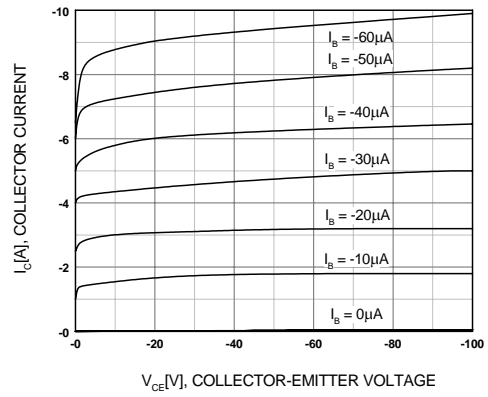

Figure 2. Static Characteristic

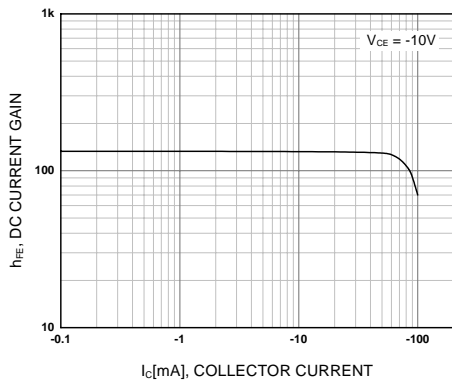

Figure 3. DC current Gain

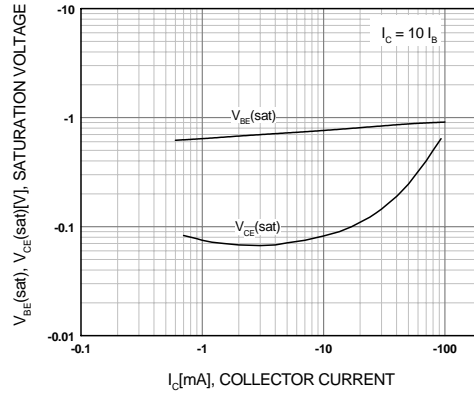

Figure 4. Base-Emitter Saturation Voltage  
Collector-Emitter Saturation Voltage

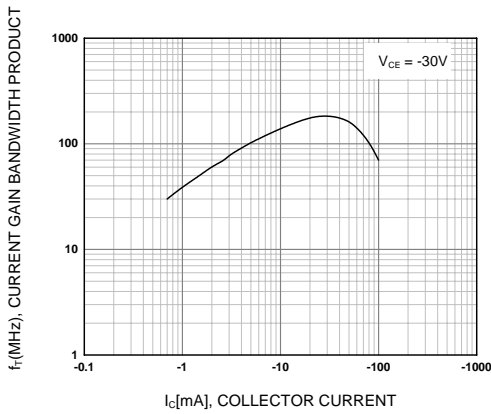

Figure 5. Current Gain Bandwidth Product

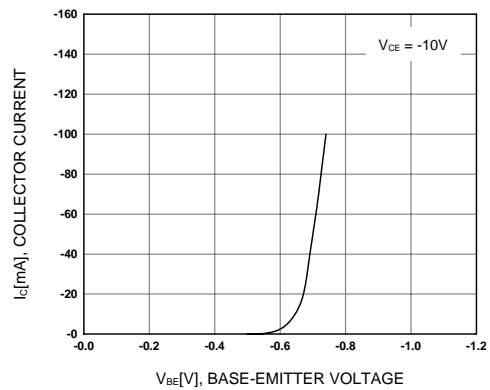

Figure 6. Base-Emitter On Voltage

Typical Characteristics (Continued)

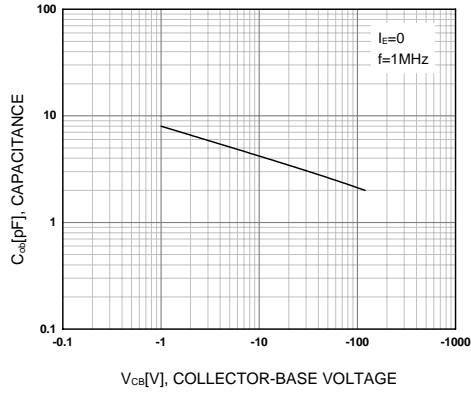

Figure 7. Collector Output Capacitance

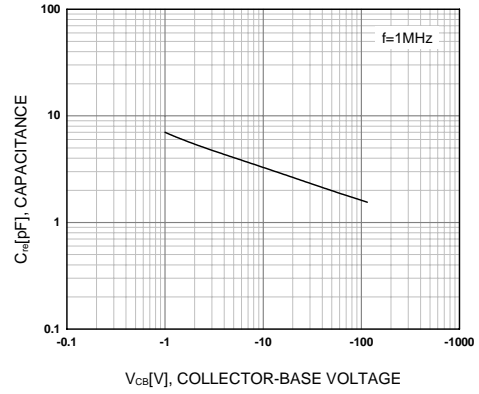

Figure 8. Reverse Transfer Capacitance

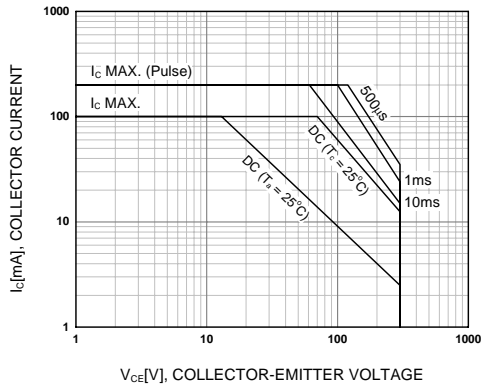

Figure 9. Safe Operating Area

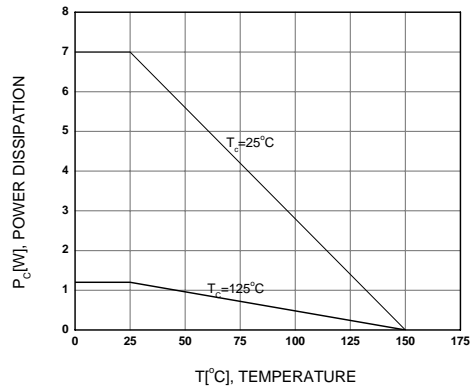
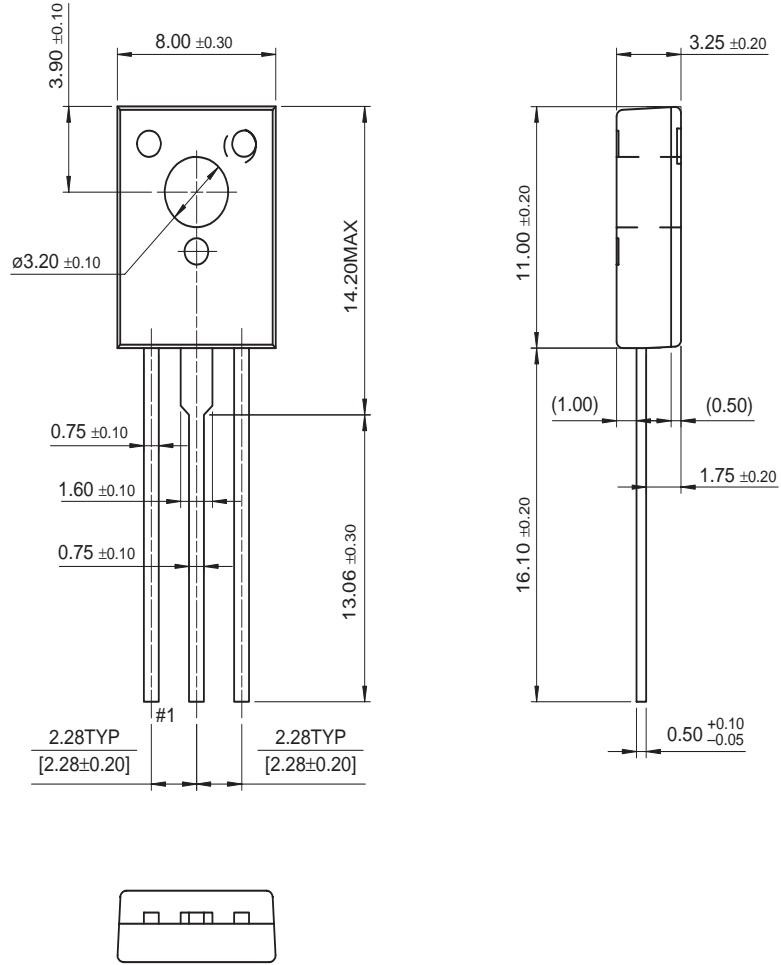

Figure 10. Power Derating

# Package Dimensions

## TO-126



Dimensions in Millimeters



**TRADEMARKS**

The following are registered and unregistered trademarks and service marks Fairchild Semiconductor owns or is authorized to use and is not intended to be an exhaustive list of all such trademarks.

- |   |   |                            |   |
|---|---|----------------------------|---|
| ACEx®   | Green FPS™  | Power247®                  | SuperSOT™-8   |
| Build it Now™   | Green FPS™ e-Series™  | POWEREDGE®                 | SyncFET™  |
| CorePLUS™   | GTO™  | Power-SPM™                 | The Power Franchise®  |
| CROSSVOLT™  | i-Lo™   | PowerTrench®               |  |
| CTL™  | IntelliMAX™   | Programmable Active Droop™ | TinyBoost™  |
| Current Transfer Logic™   | ISOPLANAR™  | QFET®                      | TinyBuck™   |
| EcoSPARK®   | MegaBuck™   | QS™                        | TinyLogic®  |
|  | MICROCOUPLER™   | QT Optoelectronics™        | TINYOPTO™   |
| Fairchild®  | MicroFET™   | Quiet Series™              | TinyPower™  |
| Fairchild Semiconductor®  | MicroPak™   | RapidConfigure™            | TinyPWM™  |
| FACT Quiet Series™  | MillerDrive™  | SMART START™               | TinyWire™   |
| FACT®   | Motion-SPM™   | SPM®                       | μSerDes™  |
| FAST®   | OPTOLOGIC®  | STEALTH™                   | UHC®  |
| FastvCore™  | OPTOPLANAR®   | SuperFET™                  | UniFET™   |
| FPST™   |  | SuperSOT™-3                | VCX™  |
| FRFET®  | PDP-SPM™  | SuperSOT™-6                |   |
| Global Power Resource <sup>SM</sup>   | Power220®   |                            |   |

**DISCLAIMER**

FAIRCHILD SEMICONDUCTOR RESERVES THE RIGHT TO MAKE CHANGES WITHOUT FURTHER NOTICE TO ANY PRODUCTS HEREIN TO IMPROVE RELIABILITY, FUNCTION, OR DESIGN. FAIRCHILD DOES NOT ASSUME ANY LIABILITY ARISING OUT OF THE APPLICATION OR USE OF ANY PRODUCT OR CIRCUIT DESCRIBED HEREIN; NEITHER DOES IT CONVEY ANY LICENSE UNDER ITS PATENT RIGHTS, NOR THE RIGHTS OF OTHERS. THESE SPECIFICATIONS DO NOT EXPAND THE TERMS OF FAIRCHILD'S WORLDWIDE TERMS AND CONDITIONS, SPECIFICALLY THE WARRANTY THEREIN, WHICH COVERS THESE PRODUCTS.

**LIFE SUPPORT POLICY**

FAIRCHILD'S PRODUCTS ARE NOT AUTHORIZED FOR USE AS CRITICAL COMPONENTS IN LIFE SUPPORT DEVICES OR SYSTEMS WITHOUT THE EXPRESS WRITTEN APPROVAL OF FAIRCHILD SEMICONDUCTOR CORPORATION.

As used herein:

1. Life support devices or systems are devices or systems which, (a) are intended for surgical implant into the body, or (b) support or sustain life, and (c) whose failure to perform when properly used in accordance with instructions for use provided in the labeling, can be reasonably expected to result in significant injury to the user.
2. A critical component is any component of a life support device or system whose failure to perform can be reasonably expected to cause the failure of the life support device or system, or to affect its safety or effectiveness.

**PRODUCT STATUS DEFINITIONS**

**Definition of Terms**

| Datasheet Identification | Product Status         | Definition   |
|--------------------------|------------------------|--|
| Advance Information      | Formative or In Design | This datasheet contains the design specifications for product development. Specifications may change in any manner without notice.   |
| Preliminary              | First Production       | This datasheet contains preliminary data; supplementary data will be published at a later date. Fairchild Semiconductor reserves the right to make changes at any time without notice to improve design. |
| No Identification Needed | Full Production        | This datasheet contains final specifications. Fairchild Semiconductor reserves the right to make changes at any time without notice to improve design.   |
| Obsolete                 | Not In Production      | This datasheet contains specifications on a product that has been discontinued by Fairchild semiconductor. The datasheet is printed for reference information only.                                      |